

High Power Laser Diode 14BF Fiber Module

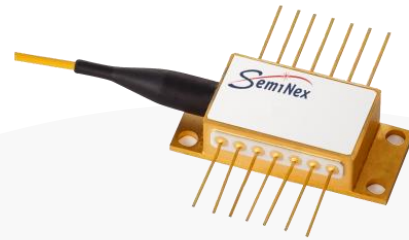

Part Number: 14BF-106

High Power 14-Pin Butterfly Fiber Coupled Module
Single-Mode Fabry-Perot
CW Wavelength at 1650nm



Features

- High Output Power
- High Dynamic Range
- High Efficiency
- 14BF Fiber Coupled Module
- Cost Effective

Application

- Optical Communications



SemiNex delivers the highest available power at infrared wavelengths between 12xx and 19xx nm. When necessary, we will further optimize the design of our InP & GaSb laser chips to meet our customers' specific optical and electrical performance needs. Diodes, bars and packages are tested to meet customer and market performance demands. Typical results and packaging options are shown. Contact SemiNex for additional details or to discuss your specific requirements.

High Power Laser Diode 14BF Fiber Module



Specification

14BF-106

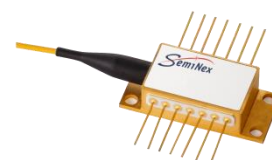

Optical	Symbol	Typ.	Units
Center Wavelength	λ_c	1650	nm (± 20)
Output Power (CW)*	P_{out}	0.18	watts ($\pm 10\%$)
Spectral Width FWHM	$\Delta\lambda$	10	nm
Slope Efficiency	η	0.2	W/A
Optical Fiber Core Dia.		9	μm
Optical Fiber NA		SMF-28	
Electrical	Symbol		Units
Power Conversion Eff.	η	9	%
Operating Current	I_{op}	1	A
Threshold Current	I_{TH}	0.05	A
Operating Voltage	V_{op}	2	V
Mechanical	Symbol		Units
Connector Type		FC/PC	
Fiber Length		1	meters
Pinout Type		Type 1	
Thermistor			
Thermistor Constant	β	3950	β
Thermistor Resistance	R	10	K ohm
		Range	
Operating Temp.**		-40 to 60	$^{\circ}\text{C}$
Storage Temp.		-40 to 80	$^{\circ}\text{C}$

*Specified values are rated at a constant heat sink temperature of 20°C.

**High temperature operation will reduce performance and MTTF.
Unless otherwise indicated all values are nominal.

High Power Laser Diode 14BF Fiber Module



SemiNex Laser Diodes 14BF-106

Graphs & Data

Typical 14BF L-I-V Characteristics

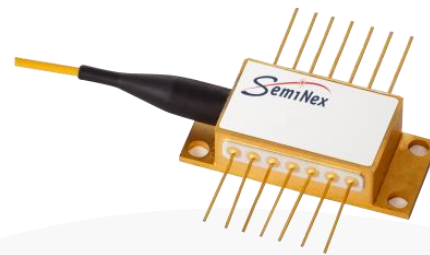
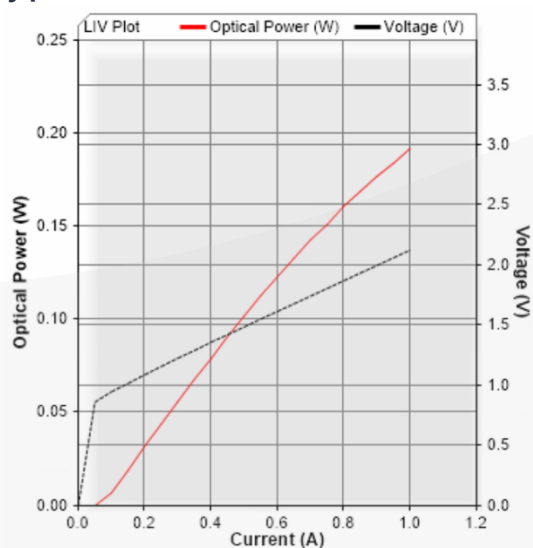

Typical 14BF Output Spectrum

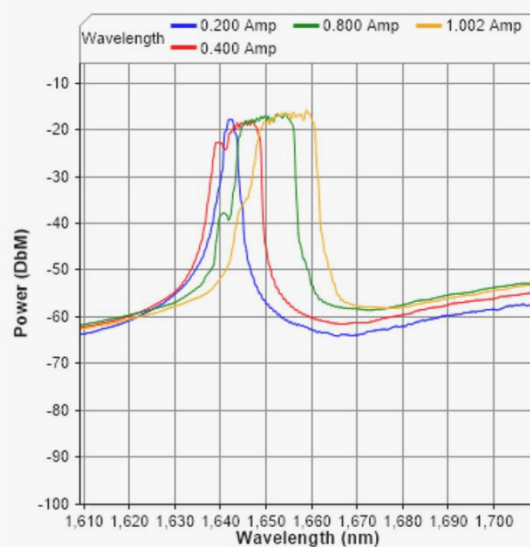

High Power Laser Diode 14BF Fiber Module



Mechanical Drawing

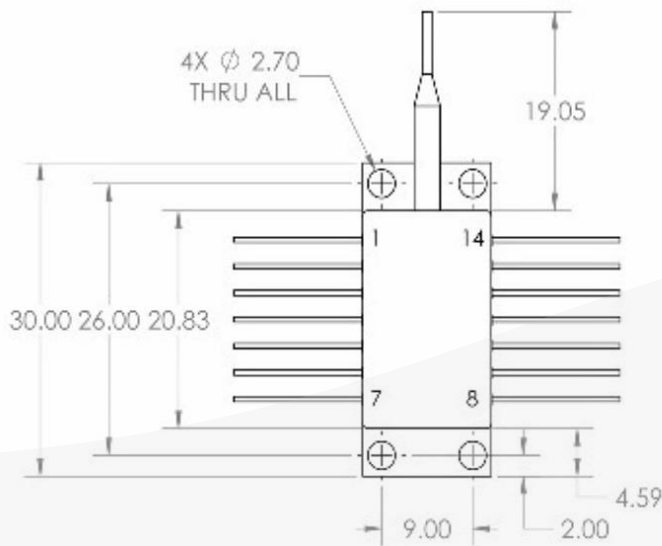
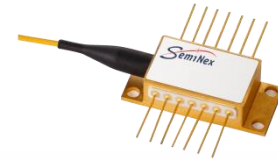

Type 1	
Pin	Function
1	TEC anode(+)
2	thermistor
3	PD anode(+)(optional)
4	PD cathode(-) (optional)
5	thermistor
6,7,8,9,12	no connection
10	laser anode(+)
11	laser cathode(-)
13	case ground
14	TEC cathode(-)

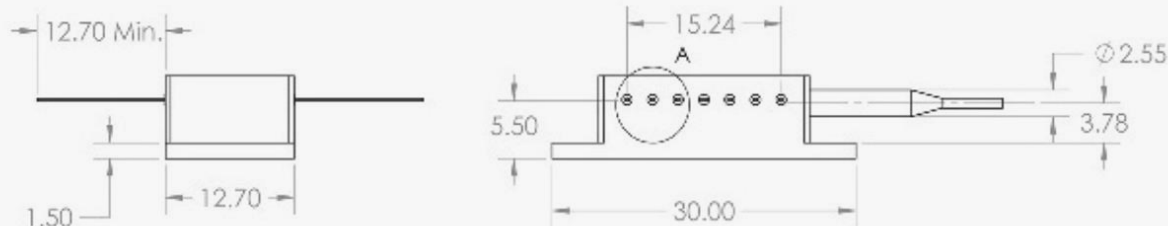

All statements, technical information and recommendations related to the product herein are based upon information believed to be reliable or accurate. The accuracy or completeness herein is not guaranteed, and no responsibility is assumed for any inaccuracies. The user assumes all risks and liability whatsoever in connection with the use of a product or its application. SemiNex Corporation reserves the right to change at any time without notice the design, specification, deduction, fit or form of its described herein, including withdrawal at any time of a product offered for sale herein. Users are encouraged to visit www.seminex.com for the latest data. SemiNex Corporation makes no representations that the products herein are free from any intellectual property claims of others. Please contact SemiNex for more information. 2024 SemiNex Corporation

