

High Power Laser Diode TO-Cans



Part Number: TO56-265

High Power Triple Junction TO56 Package
Multi-Mode Fabry-Perot
Pulsed Wavelength at 1550nm



Features

- High Output Power
- High Dynamic Range
- High Efficiency
- Standard TO56
- Cost Effective

Application

- Professional Medical
- Home Use Medical
- Laser Range Finder
- Target Illumination
- Military Systems
- TOF LiDAR for Automotive and Drones
- Telecom OTDR
- Optical Comm



SemiNex delivers the highest available power at infrared wavelengths between 12xx and 19xx nm. When necessary, we will further optimize the design of our InP & GaSb laser chips to meet our customers' specific optical and electrical performance needs. Diodes, bars and packages are tested to meet customer and market performance demands. Typical results and packaging options are shown. Contact SemiNex for additional details or to discuss your specific requirements.

High Power Laser Diode TO-Cans



Specification

TO56-265



Optical	Symbol	Typ.	Units
Center Wavelength	λ_c	1550	nm (± 20)
Output Power (<10ns)*	P_{out}	50	Watts ($\pm 10\%$)
Output Power (150ns)*	P_{out}	35	Watts ($\pm 10\%$)
Emitter Width	W	95	μm
Spectral Width FWHM	$\Delta\lambda$	22	nm
Slope Efficiency	η	0.9	W/A
Fast Axis Div.	θ_{\perp}	28	deg FWHM
Slow Axis Div.	θ_{\parallel}	12	deg FWHM
Electrical	Symbol		Units
Power Conversion Eff.	η	8	%
Operating Current (<10ns)	I_{op}	50	A
Operating Current (150ns)	I_{op}	40	A
Threshold Current	I_{TH}	2	A
Operating Voltage	V_{op}	12	V
Duty Cycle	DC	0.1	%
Mechanical	Symbol	Range	Units
Operating Temp.**		-40 to 60	$^{\circ}C$
Storage Temp.		-40 to 80	$^{\circ}C$

*Specified values are rated at a constant heat sink temperature of 20°C.

**High temperature operation will reduce performance and MTTF.
Unless otherwise indicated all values are nominal.

*Available Lenses & Caps

Suffix	Description
-138	TO-56 Cap

High Power Laser Diode TO-Cans



SemiNex Laser Diodes TO56-265

Graphs & Data

Typical TO56 L-I-V Characteristics

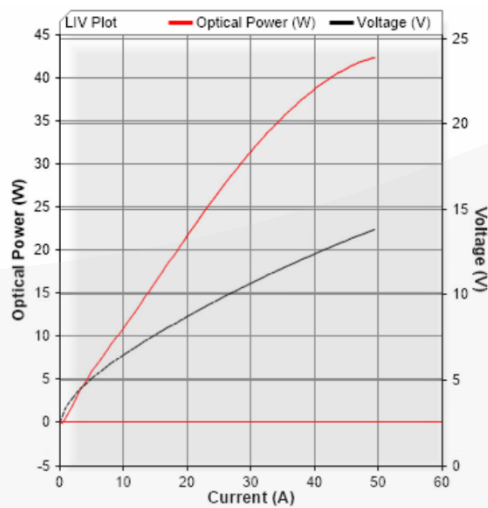

Typical TO56 Output Spectrum

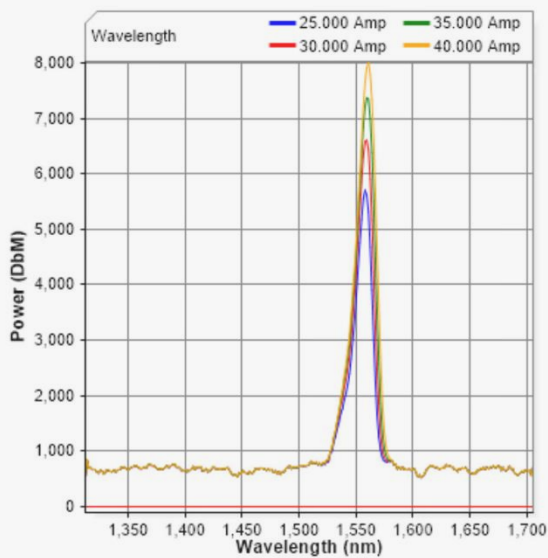

*Tested with 150nsec pulse @ 0.1% Duty Cycle

High Power Laser Diode TO-Cans



Mechanical Drawing TO56-265-138

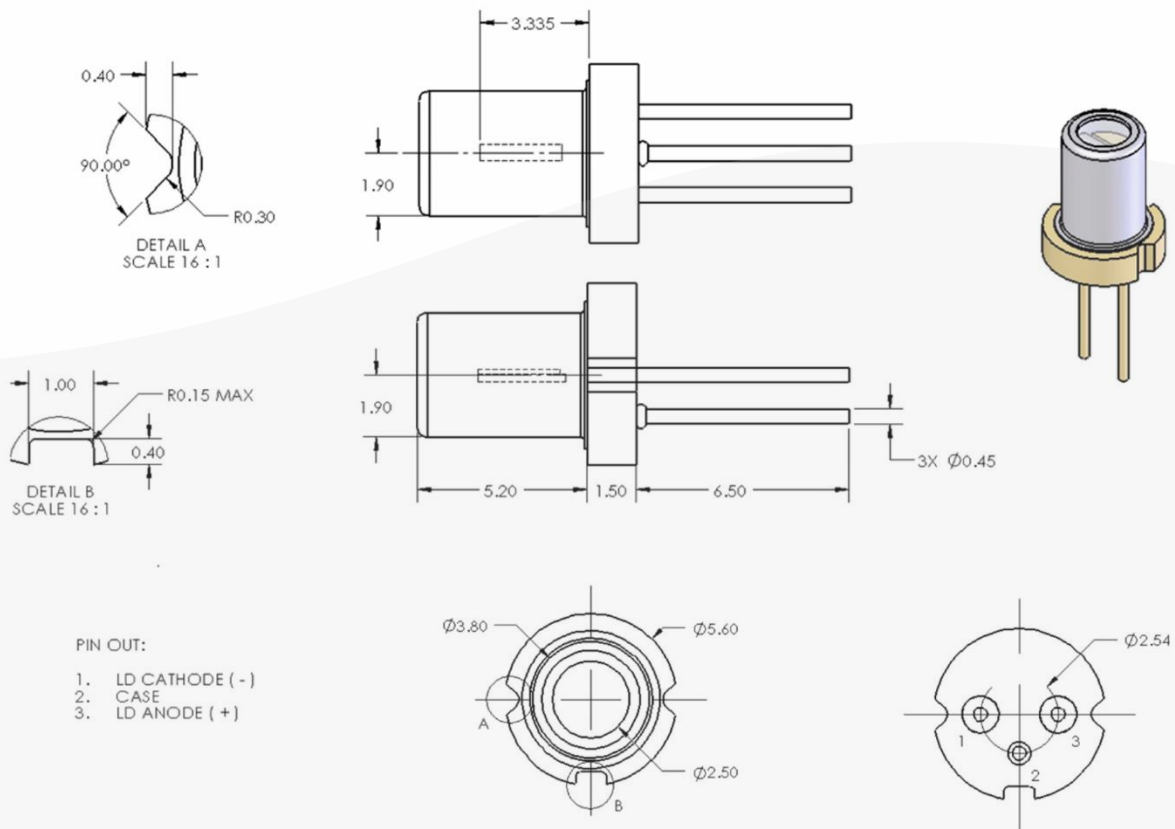

All statements, technical information and recommendations related to the product herein are based upon information believed to be reliable or accurate. The accuracy or completeness herein is not guaranteed, and no responsibility is assumed for any inaccuracies. The user assumes all risks and liability whatsoever in connection with the use of a product or its application. SemiNex Corporation reserves the right to change at any time without notice the design, specification, deduction, fit or form of its described herein, including withdrawal at any time of a product offered for sale herein. Users are encouraged to visit www.seminex.com for the latest data. SemiNex Corporation makes no representations that the products herein are free from any intellectual property claims of others. Please contact SemiNex for more information. 2024 SemiNex Corporation

